

SPECIFICATIONS

SWITCH FUNCTION: SPST, 1 thru 12 positions.
 CONTACT RATING: Switch : 25 mA @ 24VDC.
 Carry : 100 mA @ 50VDC.
 INSULATION RESISTANCE: 100M Ω min @ 500 VDC.
 CONTACT RESISTANCE: Initial : 50m Ω @ 2-4VDC @ 100mA.
 After Life : 100m Ω @ 2-4VDC @ 100mA.
 OPERATING LIFE: 2,000 make-and-break cycle each circuit.
 OPERATING FORCE: 1000gf max.
 TRAVEL, ACTUATOR: 2.0mm typical.

DIELECTRIC STRENGTH: 500 V RMS min @ sea level
 between adjacent terminals.
 CAPACITANCE: 5pf max. between adjacent terminals.
 TEMPERATURE RANGE: Operating/Storage : -40° C to 85° C.
 VIBRATION: To MIL-STD-202F. Method 201A.
 SHOCK: To MIL-STD-202F. Method 213B, Condition A.
 SOLDERING RECOMMENDATION: Wave : 500° F(260° C) for 5 sec
 max. Hand : 30W soldering iron @ 608° F(320° C) for 2s typical. Keep all
 switches in the "OFF" position during soldering and cleaning process.

HOW TO ORDER

Model No.	Actuator	NO. of Positions	ON/OFF Positions	Seal
NDS DA	R=Recessed	01~10,12		T=Top Tape Sealed
DP	N=Short key L=Long key	02~10,12		

MODEL OPTIONS

1 PC PIN

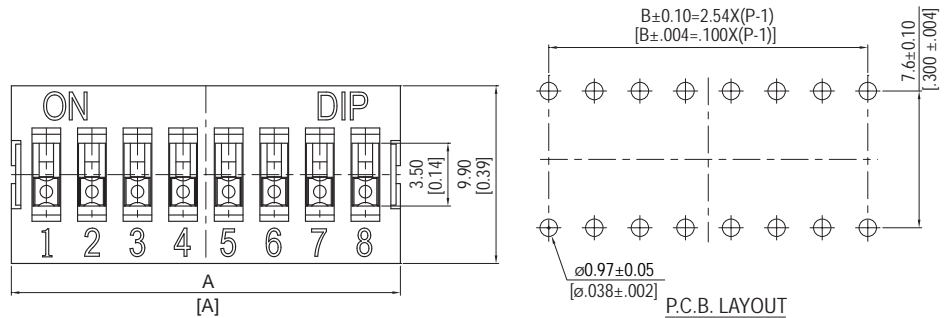
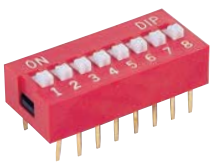

NDS

SCHEMATIC(TYP.)

 (1,2,3,4,5,6,7,8,9,10,12, POS AVAIL)

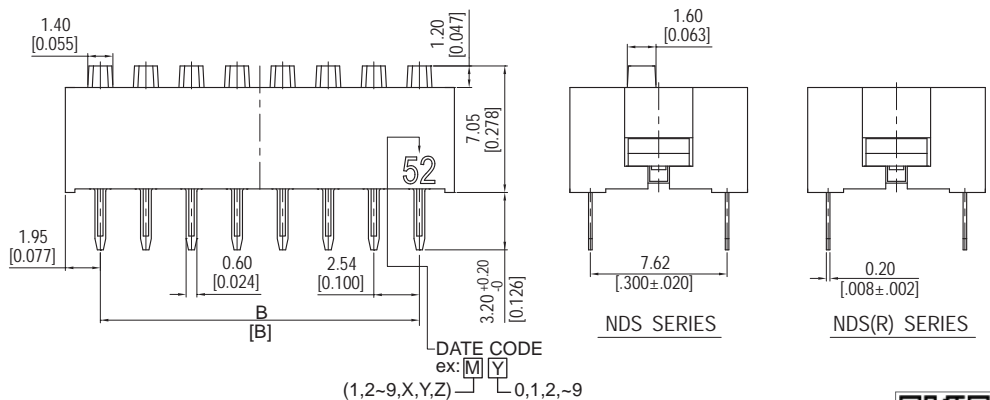

Position 1 denotes Pin NO. 1.



2 RIGHT ANGLE PC PIN

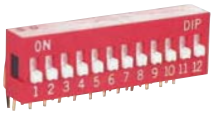

DA

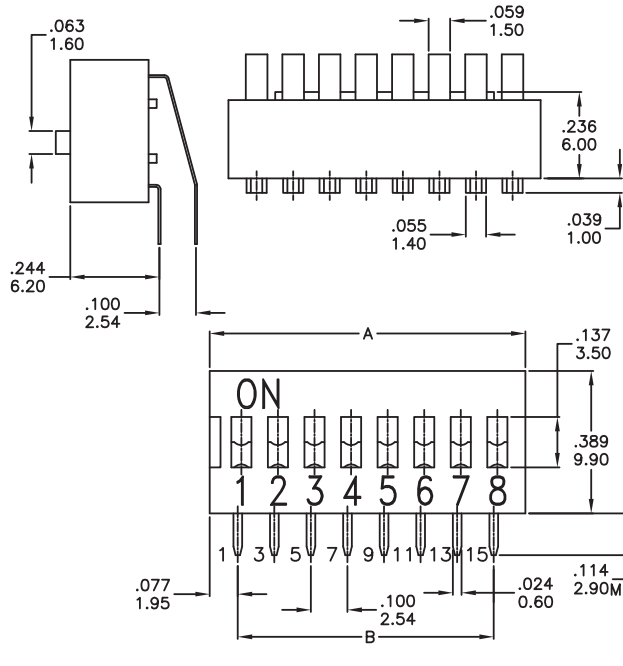

SCHEMATIC

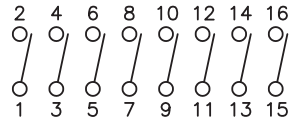

P.C. MOUNTING

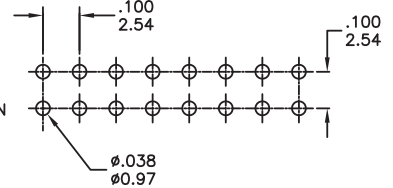

Position 1 denotes Pin NO. 1.

1 PC PIN

NDS DA DP
Dip Switches

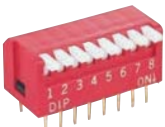

DP

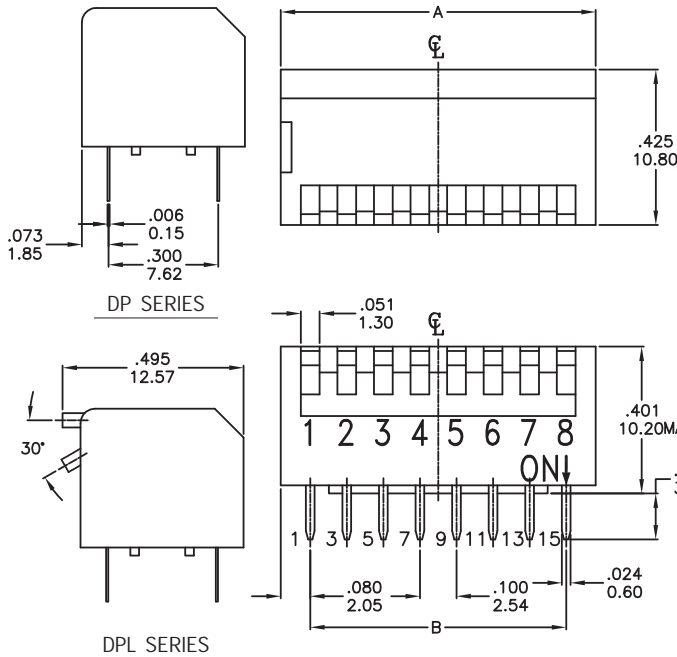

SCHEMATIC

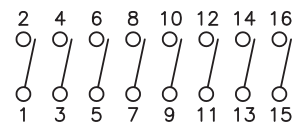

PCB MOUNTING

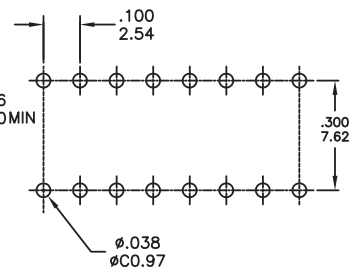

Position 1 denotes Pin NO. 1.

ACTUATOR OPTIONS

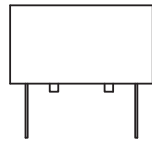

RECESSED*

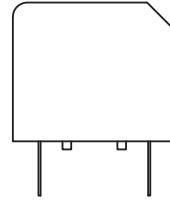

SHORT KEY
TOPSIDE "ON"

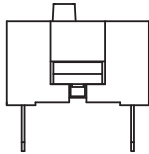

EXTENDED*

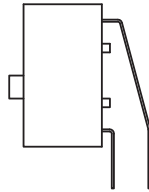

EXTENDED
TOPSIDE "OFF"

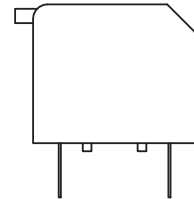

LONG KEY
TOPSIDE "ON"

NDS

DA

DP

NUMBER OF POSITIONS

NDS / DA TYPE

Positions	2	3	4	5	6	7	8	9	10	12
"A" Dimension	6.44 (.254)	8.98 (.354)	11.52 (.454)	14.06 (.554)	16.60 (.654)	19.14 (.754)	21.68 (.854)	24.22 (.954)	26.76 (1.054)	31.84 (1.254)
"B" Dimension	2.54 (.100)	5.08 (.200)	7.62 (.300)	10.16 (.400)	12.7 (.500)	15.24 (.600)	17.78 (.700)	20.32 (.800)	22.86 (.900)	27.94 (1.100)

DP TYPE

Positions	2	3	4	5	6	7	8	9	10	12
"A" Dimension	6.64 (.261)	9.18 (.361)	11.72 (.461)	14.26 (.561)	16.8 (.661)	19.34 (.761)	21.88 (.861)	24.42 (.961)	26.96 (1.061)	32.04 (1.261)
"B" Dimension	2.54 (.100)	5.08 (.200)	7.62 (.300)	10.16 (.400)	12.7 (.500)	15.24 (.600)	17.78 (.700)	20.32 (.800)	22.86 (.900)	27.94 (1.100)

SEAL OPTIONS

T TOP TAPE SEALED

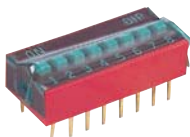

NDS



DA

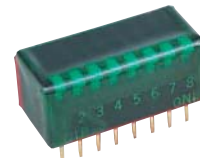

DP