

SPECIFICATIONS

CONTACT RATING: Dependent upon contact material see page 112.

MECHANICAL LIFE: 50,000 make-and-break cycles.

CONTACT RESISTANCE: 20 mΩ max. initial @ 2-4VDC

100mA for both silver and gold plated contacts.

INSULATION RESISTANCE: 1,000 MΩ min.

DIELECTRIC STRENGTH: 1,000 Vrms min. @sea level.

OPERATING TEMPERATURE: -30°C to 85°C.

CAP INSTALLATION FORCE: 10 lbs,max.permmissible.

MATERIALS

CASE & BUSHING : Glass filled Nylon 6/6, flame retardant, heat stabilized (UL 94v-0).

PLUNGER: Glass filled Nylon or Glass fille polyester (UL 94v-0).

SWITCH SUPPORT: Brass or steel, tin plate.

SWITCH SUPPORT RETAINER: Stainless steel.

N.O.&N.C. CONTACTS : Brass, with silver or gold plate over nickel plate.

COMMON CONTACTS & ALL TERMINALS :

Copper alloy, with silver or gold plated. (See Page 112)

TERMINAL SEAL : Epoxy.

IP 67
ACCORDING TO
EN 60529:1991+A1:2001
IEC 60529:2001



HOW TO ORDER

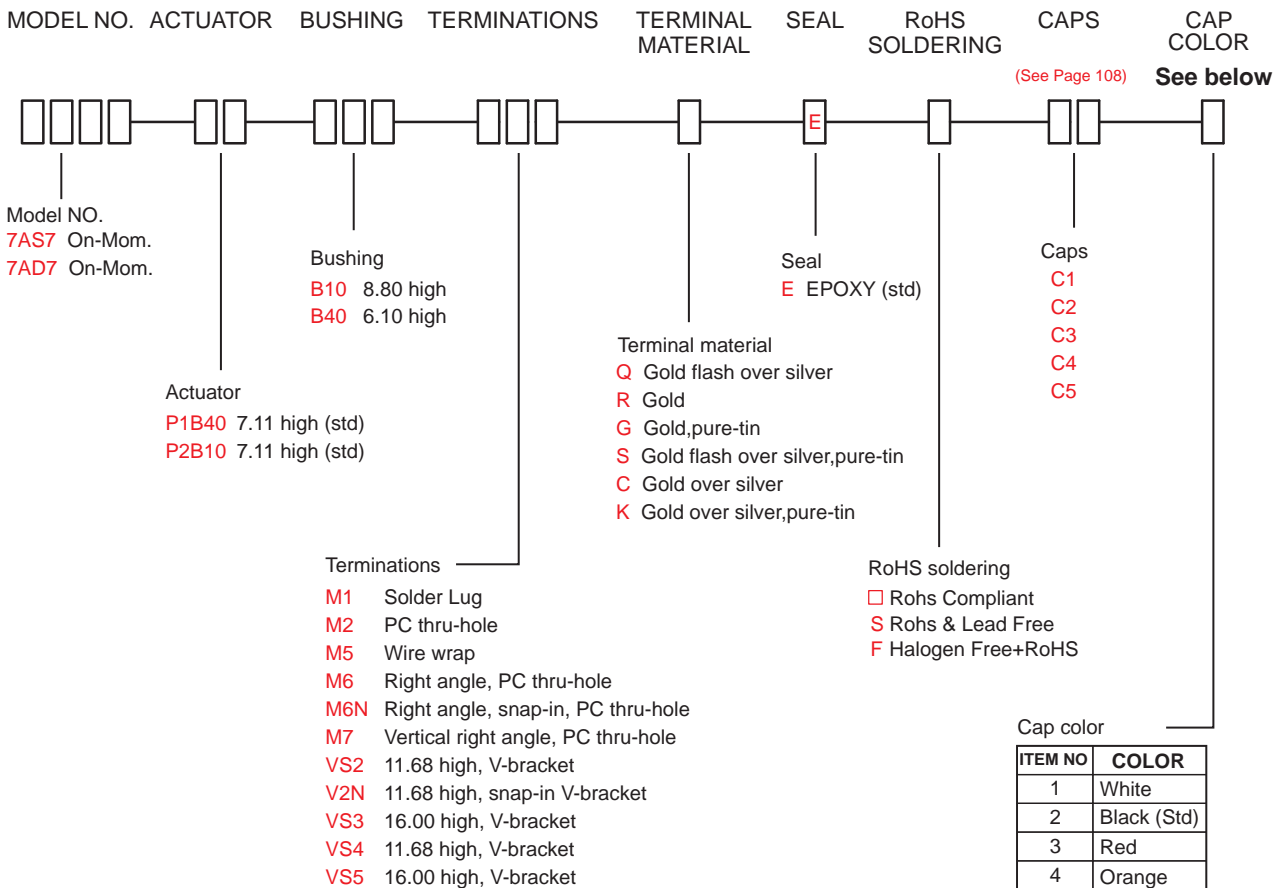

ITEM NO	COLOR
1	White
2	Black (Std)
3	Red
4	Orange
5	Yellow
6	Green
7	Blue
8	Brown
9	Gray



7A Pushbutton Switches

SWITCH FUNCTION

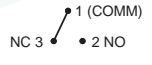
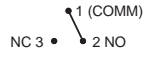
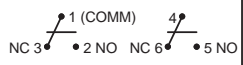
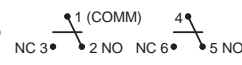
NO. POLES	MODEL NO.	SWITCH FUNCTION		CONNECTED TERMINALS / SCHEMATIC	
		POS.1	POS.2	POS.1	POS.2
SP	7AS7	ON	MOM	1-3 	1-2 
DP	7AD7	ON	MOM	1-3,4-6 	1-2,4-5 

MOM=MOMENTARY

POLE OPTIONS



SPDT

Part No. Shown : 7AS7P2B10M1QE

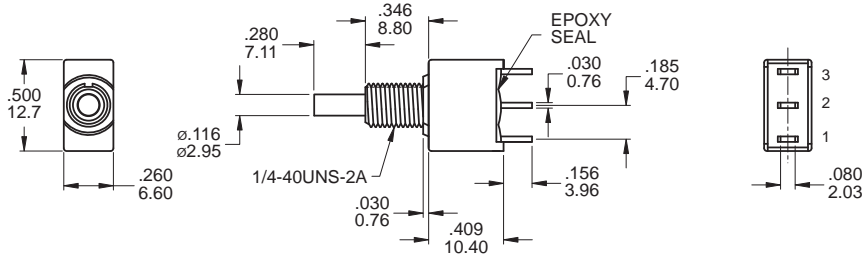

DPDT

Part No. Shown : 7AD7P2B10M1QE

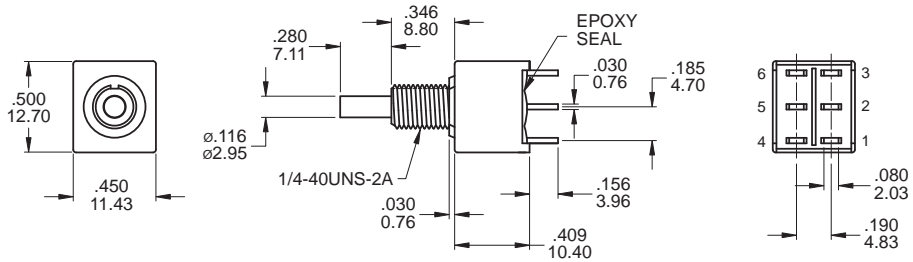

BUSHING OPTIONS

B10

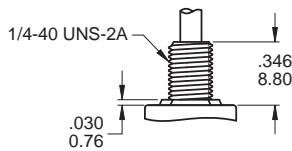

Std for M1

B40

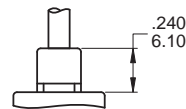

Std for M2, M6, M7, VS termination

TERMINATION OPTIONS

M1 Solder lug

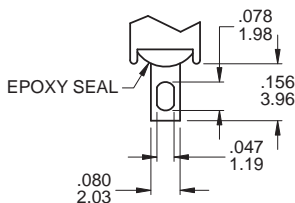

THK .030(0.76)

M2 PC Thru-hole

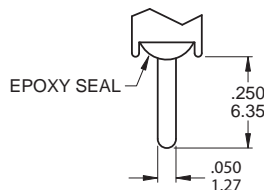

THK .030(0.76)

OTHER TERMINATION OPTIONS

M6 RIGHT ANGLE P.C. MOUNT

M7 RIGHT ANGLE P.C. MOUNT

VS2 VERTICAL BRACKET P.C. MOUNT

VS3 VERTICAL BRACKET P.C. MOUNT

7A Sealed Snap-Acting Pushbutton Switches

M6

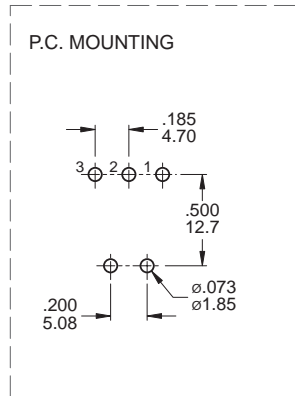
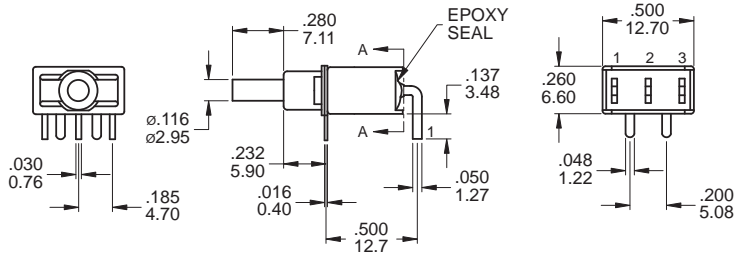

SPDT

Part No. Shown : 7AS7P1B40M6RE

M6

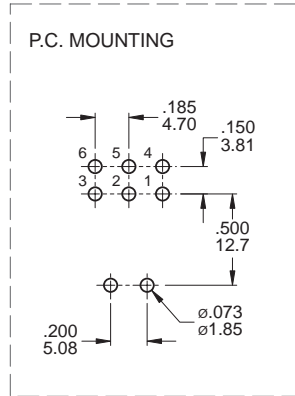
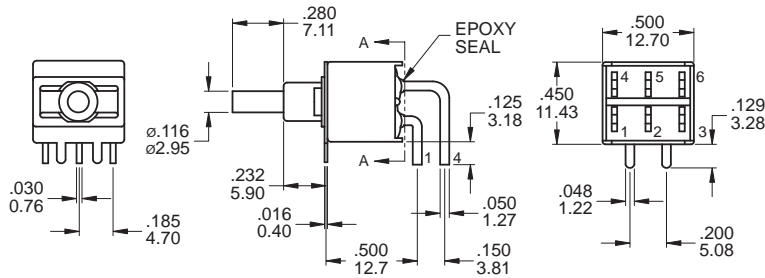

DPDT

Part No. Shown : 7AD7P1B40M6RE

M7

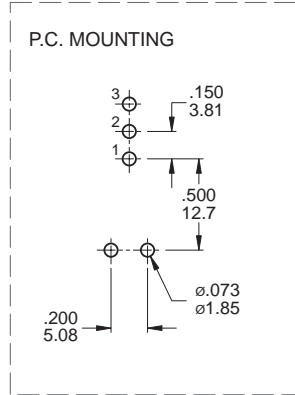
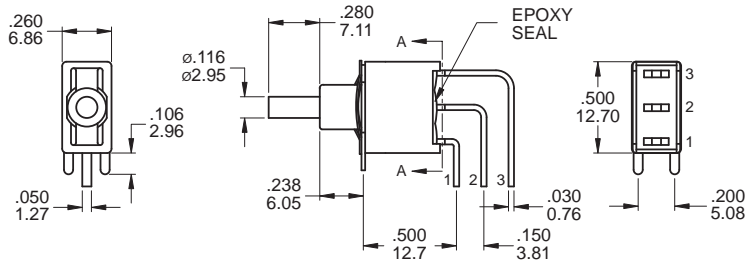

SPDT

Part No. Shown : 7AS7P1B40M7RE

M7

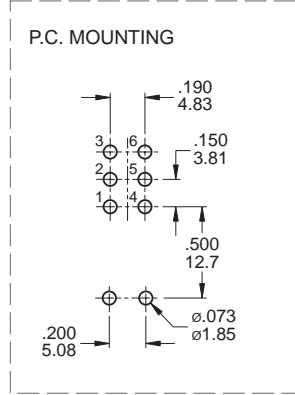
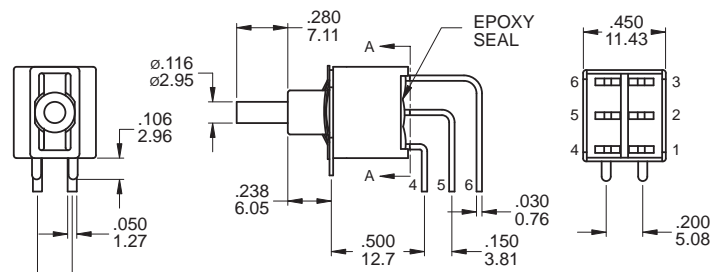

DPDT

Part No. Shown : 7AD7P1B40M7RE

7A Pushbutton Switches

VS2 - VS3

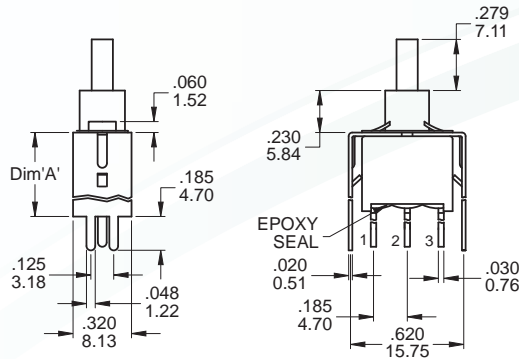

OPTION CODE	DIM. 'A'
VS2	.460 11.68
VS3	.630 16.00

P.C. MOUNTING

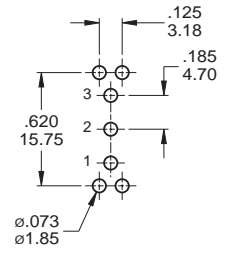

SPDT

Part No. Shown : 7AS7P1B40VS2RE

VS2 - VS3

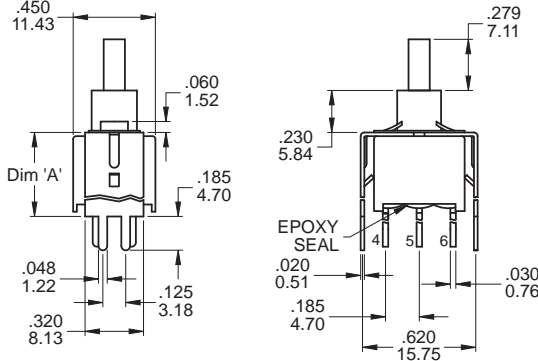

OPTION CODE	DIM. 'A'
VS2	.460 11.68
VS3	.630 16.00

P.C. MOUNTING

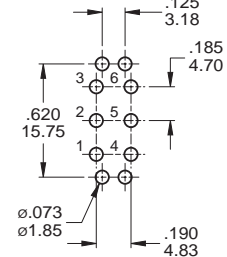

DPDT

Part No. Shown : 7AD7P1B40VS2RE

SNAP-IN TERMINATION OPTIONS

M6N



M7N



V2N

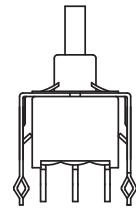

CONTACT MATERIAL OPTIONS

	CONTACT PLATING	TERMINAL PLATING	RATINGS
Q	Silver	Q = Gold flash over silver	3 Amps with resistant load @ 120VAC or 28VDC 1 Amps with resistant load @ 250VAC
S		S = Gold flash over silver,pure - tin	
C	Gold over Silver	C = Gold over silver	
K		K = Gold over silver,pure - tin	
R	Gold	R = Gold	0.4 Volt - Amps (VA) max. @ 20V max. (AC or DC)
G		G = Gold,pure - tin	

SOLDERING PROCESSES

MANUAL SOLDERING: Use soldering iron of 30 watts, controlled at 350°C approximately 5 seconds while applying solder.

WAVE SOLDERING: Recommended Soldering Temperature: 260 ± 5°C

Duration of Solder Immersion: Max 5 sec. (PCB is 1.6mm in thickness)

